

Donaldson®
Torit®

DUST, FUME & MIST
COLLECTORS, FILTERS
& REPLACEMENT PARTS



THE MARKET LEADER

FOR LONG-TERM VALUE

For decades, Donaldson® Torit® has offered manufacturers advanced and reliable dust, fume and mist collectors and filters engineered to provide outstanding filtration efficiency and energy savings. The pairing of these industry-leading collectors and filters helps increase manufacturing efficiencies and cleaner environments for employees.







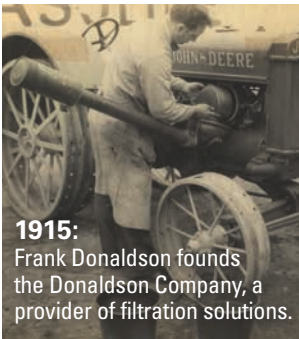

When efficiency is maximized and employees are at their peak, so is the manufacturer's productivity — and ultimately, its bottom line. Donaldson Torit products can help safeguard that bottom line with innovative collectors and filters, expertly engineered by its unparalleled team of R&D engineers to provide long-term value, rather than short-term savings.

No other dust collection manufacturer can match Donaldson Torit's filtration solutions in delivering clean air.

SUPERIOR PERFORMANCE

Integrated collectors and filter media work together to offer the highest levels of efficiency and maximize productivity.

CONTINUALLY EVOLVING FILTRATION SOLUTIONS

1900	1980	1990	2000
ACQUISITIONS			
<p>1915: Frank Donaldson founds the Donaldson Company, a provider of filtration solutions.</p> 	<p>1974: Donaldson Company, Inc. acquires the Torit Corporation, resulting in unparalleled filtration and cartridge expertise.</p> 	<p>1983: The Downflo® horizontal cartridge collector is introduced, offering a higher efficiency and smaller footprint than any collector before it. Also offers up to 25% more airflow than TD.</p> 	<p>1997: Donaldson Torit's mist collection portfolio is expanded by the acquisition of Aercology.</p> 
			<p>2000: Donaldson acquires DCE, expanding its baghouse portfolio.</p> 
TECHNOLOGY			
	<p>1975: The TD cartridge collector is launched, the first vertical cartridge collector introduced to the dust collection market.</p> 	<p>1981: Donaldson Torit creates proprietary Ultra-Web® fine fiber filter media, increasing filtration efficiency, and filter life while simplifying maintenance.</p> 	<p>1986: Donaldson Torit expands its product line and expertise to baghouse collectors with the acquisition of Carter Day, another dust collection leader.</p> 
			<p>2000: Downflo® Oval 1™ is launched providing up to 25% more airflow than competing collectors and DFT.</p> 

ADVANCED TECHNOLOGY

As the inventor of the cartridge collector, Donaldson® Torit® has led the way for continuous innovation with award-winning products such as Torit® PowerCore® dust collectors and filter packs.

Proprietary Ultra-Web® fine fiber filter media – the first of its kind – was developed by Donaldson. On the market for three decades, this media technology increases filtration efficiency and simplifies maintenance.

RELIABILITY

The leading worldwide provider of advanced filtration technology for almost 100 years.

CUSTOMER SUPPORT

Unmatched service and support at all stages—from up-front engineering to knowledgeable field resources to after-sales service. Worldwide support to provide customers with advanced solutions and service, no matter the location.

2005

2010

2015

2004:

Donaldson Torit offers a full line of replacement filters for competitor brands.

2005:

Donaldson Torit introduces Ready2Ship, a service that ships replacement filters within 24 hours of ordering.

2008:

Donaldson Torit acquires LMC-West and further expands its baghouse portfolio.

2015:

Donaldson Torit acquires a majority stake in IFIL USA and delivers pleated filter bag elements with Ultra-Web fine fiber filter media to the market.

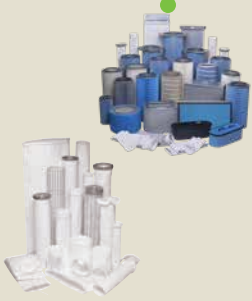

2003:

Dura-Life™ bag filters are introduced—providing increased efficiency and twice the life over standard polyester bags.

2006:

Synteq XP™ Media Technology is introduced, an advanced media with higher efficiency and superior draining function for the collection of aerosolized mist.

2008:

Torit® PowerCore® is launched – collectors that are up to 70% smaller and use compact filter packs, resulting in reduced maintenance costs.

2014:

Downflo® Evolution is launched with revolutionary airflow management and 27% more cleaning energy to filtration media.

2017:

Packaged Downflo® Evolution extends Torit's best-in-class cartridge technology with a line of dust collectors with integrated filtration, fan, and controls.

TORIT® POWERCORE® COLLECTORS

SMALLER. SMARTER.

Torit® PowerCore® dust collectors with PowerCore® filter packs solve the industry’s need for better filtration, reduced operational cost, a smaller footprint and easier maintenance. Less steel and oil are required to manufacture and transport collectors that are 50 - 70 percent smaller than traditional collectors. Clean-side filter pack access and fewer, lighter filter packs mean faster, easier filter changes without tools or filter cages. An optimized airflow management system delivers optimal pulse cleaning while minimizing airflow restriction. Also, collectors are shipped with filter packs installed.

Additionally, smaller sized Torit® PowerCore® collectors can eliminate the need for complicated ductwork or a large, energy-consuming central dust collection system. With greater flexibility, manufacturers can now optimize space on the plant floor while containing costs. Innovative PowerCore® filtration technology means reduced freight and installation costs, fewer filter pack changeouts, lower maintenance costs, and no entry requirements for filter pack changes.



(5,000 cfm collectors)
Torit PowerCore CPC-12
(12 7-ft filter packs) vs.
Traditional Baghouse
(81 8-ft filters)



(1,500 cfm collectors)
Torit PowerCore CPV-3
(3 7-ft filter packs) vs.
Traditional Bin Vent
(16 6-ft bags)



(5,500 cfm collectors)
Torit PowerCore TG4
(4 cartridges) vs. Traditional
Collector (8 cartridges)

CP Series

TG Series

CPC

CPV

TG

(700 - 33,000 cfm)
(1,189 - 56,055 m³/h)

(450 - 8,200 cfm)
(764 - 13,929 m³/h)

(960 - 13,440 cfm)
(1,631 - 22,830 m³/h)

A stand-alone collector that can be ducted to many different applications including grain, wood dust, plastic cutting, and food.

Tool-free filter changeout accessed on the clean side of the collector is faster and easier than a traditional baghouse collector.

Bin vent collector designed for use in material-handling applications – even in tight spaces – including silos, conveyor transfer points, conveyor discharges, blenders, and mixers.

Designed for thermally generated metalworking applications like welding, laser and plasma cutting, and thermal spray.

No tools required

T-Handles provide immediate access to the easy-grip PowerCore filter packs.

POWERCORE® MEDIA TECHNOLOGY

LEADING THE WAY WITH POWERCORE

PowerCore® media technology is integral to the dramatic downsizing of the Torit® PowerCore® collector. PowerCore® filter packs combine Ultra-Web® fine fiber technology with Donaldson's media configuration expertise, creating a new filtration structure unlike anything else in the industrial air filtration market. As a result, a more effective filtration area is packaged into smaller spaces. And just one Torit® PowerCore® filter pack replaces multiple cartridge or bag-style filters. With more media packed into a smaller space and a simplified airflow path, PowerCore® filter packs provide high performance with a low pressure drop.

HIGH PERFORMANCE FILTER MEDIA

- One Torit PowerCore filter pack replaces multiple cartridge or bag-style filters
- Fast and easy filter pack changes
- Reduced maintenance
- High filtration efficiency for reduced emissions
- Reduced freight & installation costs
- Technology proven in field applications for more than 10 years

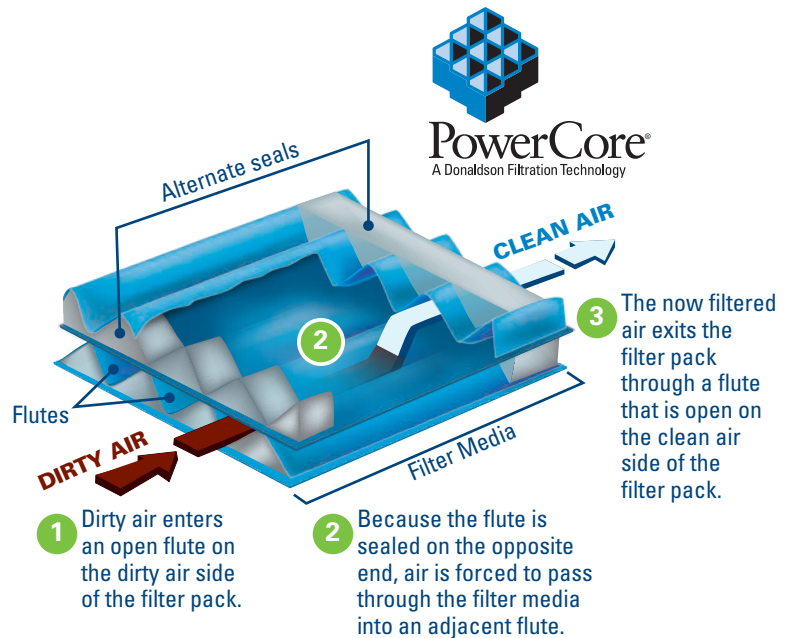

ONE POWERCORE FILTER PACK

REPLACES UP TO

CP
filter pack



SIX 8-ft. long bag filters

TG
filter pack



THREE cartridge filters

CARTRIDGE COLLECTORS

THE INVENTOR OF THE CARTRIDGE COLLECTOR

As the inventor of the cartridge collector, Donaldson® Torit® has led the way with continuous innovation, such as the award-winning Downflo® Oval dust collection technology. No other manufacturer comes close to matching the innovation and breadth of technical expertise that Donaldson Torit incorporates into its cartridge collectors.

Donaldson Torit engineers its cartridge collectors to capture the broad spectrum of dust particles that can inhibit the production environment. From portable to central collectors, to source and ambient collectors, to booth-type collectors and weld benches, Donaldson Torit provides the most complete range of cartridge collectors that cost-effectively enhance productivity and manufacturing efficiency.



Downflo® Evolution



Downdraft Bench



Downflo® WorkStation



Downflo® Oval



Fume Collectors

AT-3000 T-2000™ Weld Bench

Easy-Trunk™ Porta-Trunk™ Extraction Arms

(750-80,000 cfm)
(1,189 - 5,096 m³/h)

(700 - 3,000 cfm)
(1,189 - 5,096 m³/h)

(5,800 - 28,000 cfm)
(9,854 - 47,572 m³/h)

(90 - 102,000 cfm)
(153 - 173,262 m³/h)

T-2000
(890 cfm)
(1,512 m³/h)
Weld Bench
(2,000 - 3,000 cfm)
(3,397 - 5,096 m³/h)

(750 - 780 cfm)**
(1,274 - 1,325 m³/h)

The DFE is a smaller cartridge collector with fewer filters. Airflow management directs incoming air to an intelligent dropout zone for reduced filter loading, and MaxPulse™ Cleaning System with a triangular filter delivers 27% more cleaning energy to filtration media.

Self-contained dust collector bench for grinding and finishing operations.

Designed specifically for in-plant areas where dirty and/or noisy operations are out in the open – grinding, sanding, chipping, batch mixing or welding.

DFO is a one-of-a-kind series of cartridge dust collectors with oval-shaped filter technology, proprietary filter media and pulse cleaning that provides up to 25% more airflow capacity than same-sized round cartridge collectors.

T-2000 and AT-3000 ceiling-mount, self-contained source collectors capture fume generated in moderate-to-heavy welding applications. Weld Bench provides high capture velocity that assures fume capture and eliminates the need for extraction arms.

Offering compact, portable filtration of smoke, dust and fumes that result from welding and grinding applications, Easy-Trunk provides built-in manual pulse filter cleaning. Porta-Trunk is a static filter system.

ULTRA-WEB® MEDIA TECHNOLOGY

THE INVENTOR OF ULTRA-WEB

Proven for 30 years, advanced and improved many times over, proprietary Ultra-Web is the fine fiber media technology that outperforms all others; it delivers longer filter life, cleaner air, and greater savings.

Donaldson® Torit® offers a complete line of Ultra-Web cartridge filters that last twice as long as or more than commodity cellulose and cellulose/synthetic (80/20) blend medias. The Ultra-Web surface-loading technology is scientifically proven to provide a lower operating pressure drop over a longer period of time, which allows the filter to last longer while requiring less energy.

Ultra-Web fine fiber media is the most optimized and cost-effective choice available for most all dust and fume collection applications.

Experience the Ultra-Web advantage:

- Increased surface loading
- Enhanced dust cake release
- Better cleaning efficiency
- Lower cost per cfm
- Available for all popular brands of dust collectors

ULTRA-WEB
OUTPERFORMS ALL
OTHERS

10 Micron
Particulate
at 600X

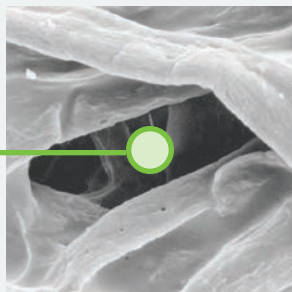
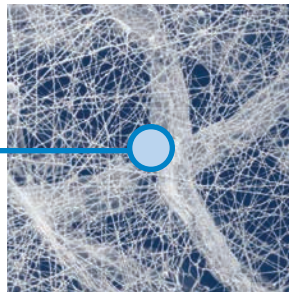

CELLULOSE

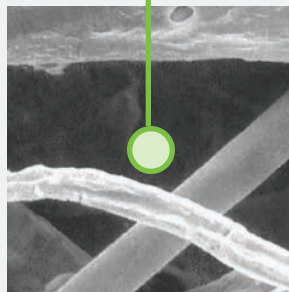

CELLULOSE/
SYNTHETIC

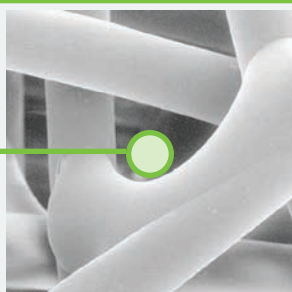

SPUNBOND

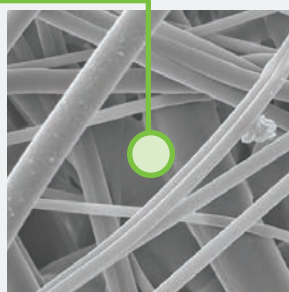

MELTBLOWN

1 micron = 1/25,400 of an inch (1/1,000 of a millimeter)



ULTRA-WEB®

**3 DECADES OF
LEADERSHIP &
OVER 5 MILLION
FILTERS SOLD**

BAGHOUSE COLLECTORS

THE RIGHT BAGHOUSE FOR THE APPLICATION

Donaldson® Torit® offers a complete line of dependable, rugged baghouse dust collectors ranging from small Cyclones and Unimaster® collectors that handle as low as 120 cfm to large RFs and LPs that handle up to 197,000 cfm. Donaldson Torit also offers unique collectors like the Dalamatric®, which feature envelope-shaped bags for improved pulse cleaning of especially challenging dusts, and **clean side access** to filters to make changeouts easier.

In addition to offering the best baghouses on the market, Donaldson Torit continually develops industry-leading technologies such as Dura-Life™ bag filters that provide longer filter life, increased efficiency, and reduced operating costs.



RF and LP Baghouse



Unimaster®



Dalamatric® Cased – DLMC Insertable – DLMV



IRD Dust Collector



Modular Baghouse

(2,000 - 197,000 cfm)
(3,397 - 334,634 m³/h)

(120 - 10,000 cfm)
(204 - 16,987 m³/h)

(170 - 85,000 cfm)
(289 - 144,385 m³/h)

(1,350 - 5,000 cfm)
(2,293 - 8493 m³/h)

(1,150 - 65,000 cfm)
(1,953 - 110,412 m³/h)

The award-winning RF and LP are larger baghouses that combine cyclone style pre-separation and baghouse filters in one collector. They also provide non-compressed air cleaning. The RF uses low pressure cleaning while the LP uses reverse air cleaning.

The UMA is a complete unit that is suited for intermittent duty applications where compressed air is not available. This unit uses a superior shaker design to clean the bags for optimized airflow. Everything needed is packaged in one compact unit (including fan and controls).

The Dalamatricline of collectors uses envelope-shaped bags that provide extra snap during pulsing for use in especially challenging dust applications. The DLMC is a stand-alone collector with hopper, while the DLMV comes without hopper for use in bin venting and transfer point applications.

The IRD is an economical, continuous duty collector for wood dust applications. This easy-to-install collector, complete with fan, comes with everything needed to start clearing the air. Just assemble, hook up ductwork and let it go.

Designed for fast, easy installation and simple, reliable dust collection, Modular Baghouses provide high performance filtration in applications with high air volumes and heavy dust loading.

TWO BREAKTHROUGH FILTER OPTIONS FOR YOUR BAGHOUSE



DURA-LIFE FILTER BAGS PROVIDE TWICE THE LIFE OVER STANDARD 16 OZ POLYESTER BAGS

Traditional 16 oz polyester bags are produced via a needling process that creates larger pores where dust can embed into the fabric, inhibiting cleaning and reducing bag life. Dura-Life bags are engineered with a unique hydroentanglement process that uses water jets to blend the fibers. This process creates a felt with smaller pores which keeps more dust on the surface of the filter resulting in better pulse cleaning and longer bag life.

DURA-LIFE BENEFITS

- Up to two times longer bag life
- Energy savings due to lower pressure drop
- Reduced replacement bag and maintenance costs due to longer bag life



PLEATED BAGS WITH ULTRA-WEB SB PROVIDE LONGER LIFE AND REDUCED EMISSIONS

For more than two decades, Donaldson Torit has advanced the proven Ultra-Web fine fiber technology. Ultra-Web provides a very fine, continuous fiber of 0.2-0.3 micron in diameter to form a web-like net that traps dust on the surface of the media. Combining Ultra-Web technology with a sturdy spunbond polyester substrate, Ultra-Web SB pleated bag filters provide longer life, reduced downtime and reduced emissions.

ULTRA-WEB SB PLEATED BAG BENEFITS

- Up to two times longer filter life
- Energy savings due to lower pressure drop
- Reduced maintenance and downtime costs
- Reduced emissions

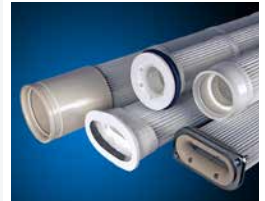

10 micron

1 micron = 1/25,400 of an inch
(1/1,000 of a millimeter)

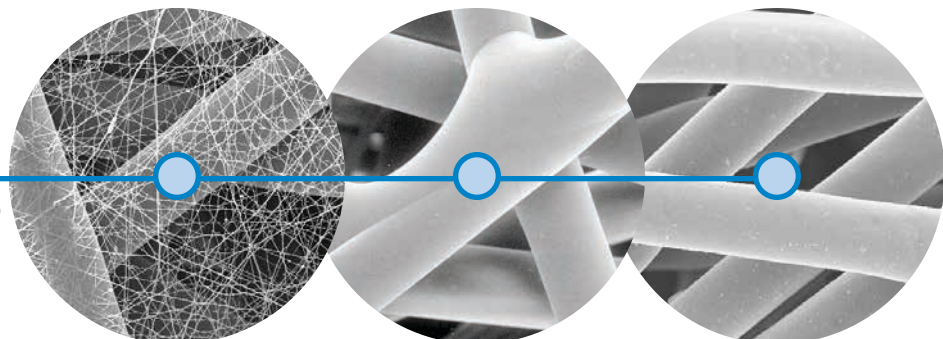

Ultra-Web SB
Fine fiber Technology
(600x)

Spunbond
Media
(600x)

Standard 16 oz.
Polyester Media
(600x)

MIST COLLECTORS

A COMPREHENSIVE RANGE

High performance mist collection is a must for manufacturers that generate coolant and machining oil mist in their applications. Uncollected mist leaves condensation and residue on floors, machines, walls and ceilings, creating a potentially unsafe and unclean manufacturing environment.

Donaldson® Torit® provides a comprehensive range of mist collectors, each providing the peace of mind manufacturers need to be productive and efficient.

Rely on Donaldson Torit for the most advanced mist collection technology.

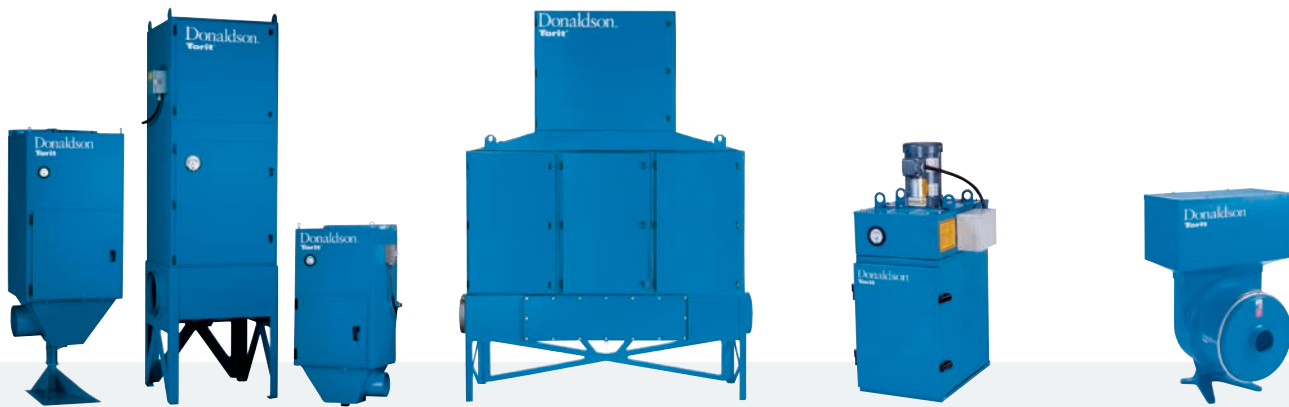

WSO
LONGEST LIFE OPTION

(450 - 5,550 cfm)
(764 - 9,428 m³/h)

WSO mist collector is the only collector that filters three types of mist (water, smoke, oil) in one collector – simply by tailoring the filter. Designed to collect water-soluble coolant, straight oil, and the most challenging – oily smoke – from a variety of machining operations and other industrial processes. The WSO design has several configurations such as machine mountable, stand mount, ducted cellular and central system to meet your plant requirements.

Modular MediaFilter™

(1,000 - 6,000 cfm)
(1,699 - 10,192 m³/h)

Modular MediaFilter provides flexible, high performance mist collection for applications such as grinding, wet grinding, wet machining, rubber machining, die casting and soldering. Available in vertical and horizontal models, Modular MediaFilter collectors are expandable to adapt to changing needs such as smoke, dust and fume filtration, saving the cost of a new filtration system.

Mini-Mist

(300 - 1,200 cfm)
(510 - 2,038 m³/h)

Designed to collect coolant mists from CNC machining, grinding, turning, milling and drilling operations, compact Mini-Mist collectors are effective alone or can be integrated into larger machining operations.

Centrifugal

(100 - 1,000 cfm)
(170 - 1,699 m³/h)

Centrifugal collectors offer compact, high efficiency and economical mist collection. They can be used to reclaim mist in applications that process petrochemicals or synthetic coolants. They are particularly effective at handling very heavy mist loading concentrations.

SYNTEQ XP™ MEDIA TECHNOLOGY

ADVANCED FILTER MEDIA FOR MIST

Proprietary Synteq XP is a revolutionary and proprietary media for mist collection that provides higher efficiency, low operating pressure drop, and longer filter life when compared to traditional media.

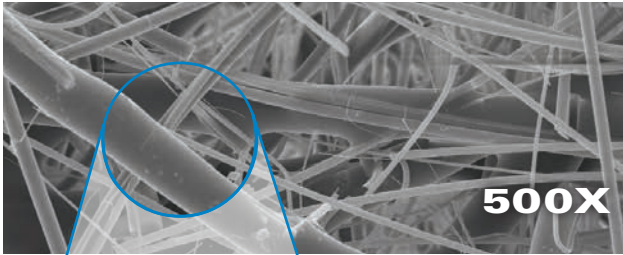

500X



Micro-glass
for filtration

Bi-component
binding fiber

SYNTEQ XP MEDIA WITH RESIN-FREE BINDING FIBERS

- Fast and easy filter pack changes
- Engineered blend of small and large fibers, with proprietary, resin-free bonding system
- Small fibers are scientifically proven to increase efficiency through superior draining
- Large fibers provide structural support and clear drain channels to sustain performance in the most challenging applications
- Proprietary bonding system stabilizes pore structure for optimum performance and longer life
- Available for many brands of mist collectors

During the media manufacturing process, the surface of the binding fiber is heat fused to make it bond to the surrounding micro-glass – no resin webbing to block pores.



A RANGE OF COLLECTORS

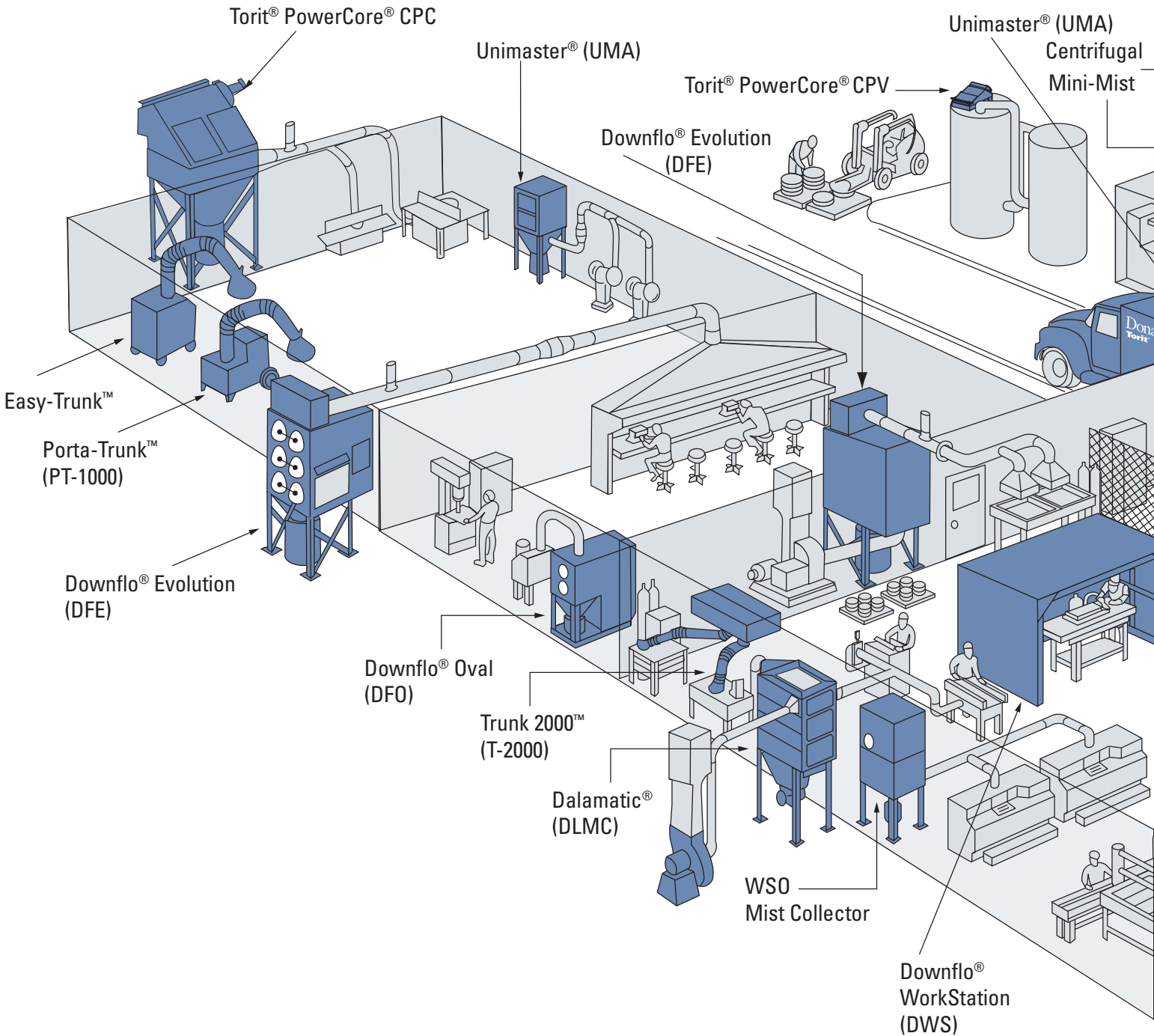

OSHA & NFPA REQUIREMENTS

Donaldson® Torit® offers a variety of dust collectors, options, and accessories to help manufacturers comply with the collector sections of NFPA/OSHA standards on combustible dust. Contact a local Donaldson Representative, or call 800-365-1331, to schedule an on-site review of your filtration needs, and to determine what filtration equipment will support your course of action for NFPA/OSHA compliance on combustible dust.

HELP PROTECT YOUR BOTTOM LINE

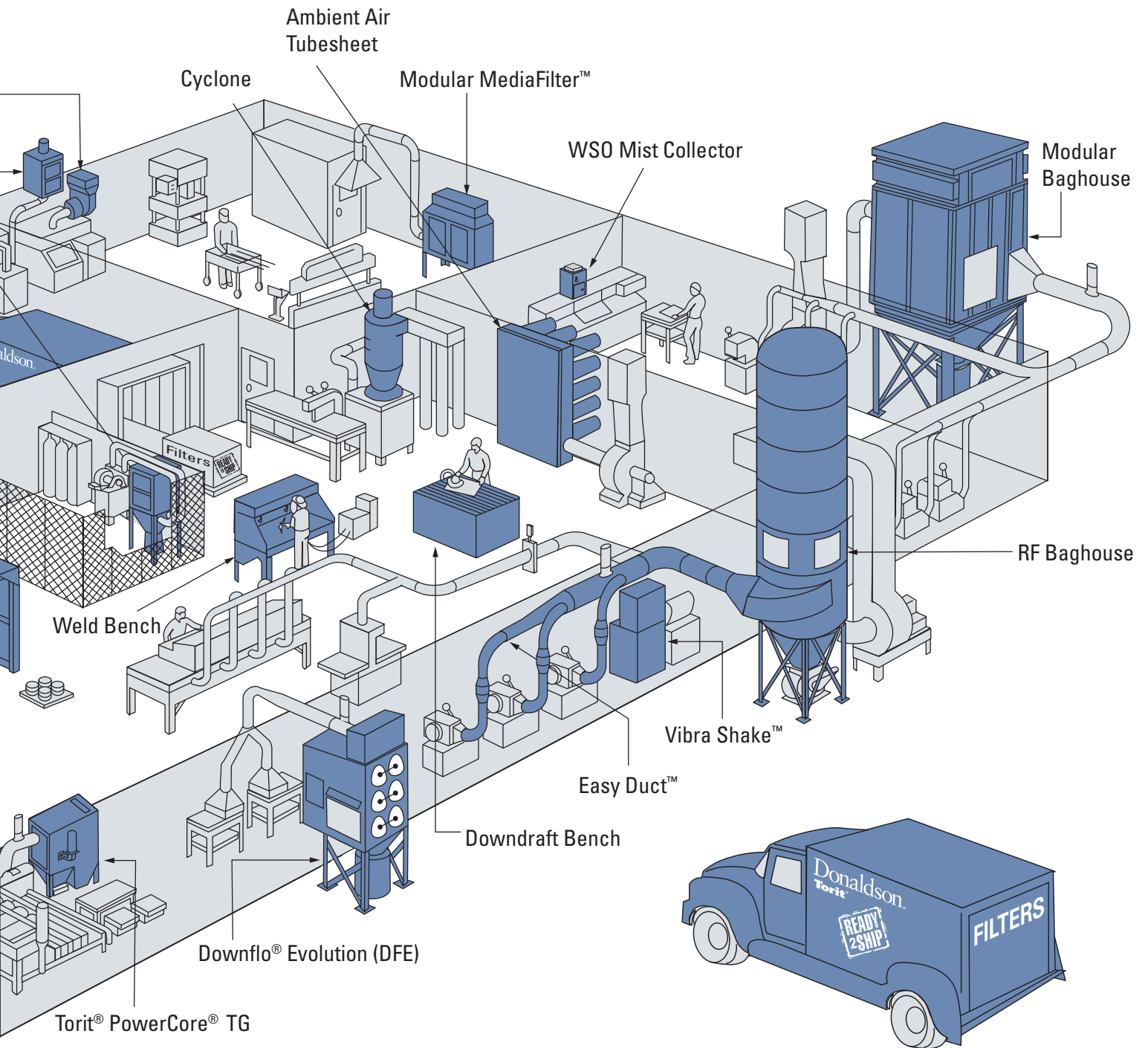

When employees are at their peak, so is productivity—and ultimately, a manufacturer's bottom line. Collectors and filters, expertly engineered by Donaldson Torit's unparalleled team of R&D engineers, provide long-term value rather than short-term savings.

METALWORKING APPLICATIONS



TG on Plasma Cutting
2,300 cfm (3,90 m³/h)



DFO on Grinding
74,000 cfm (125,700 m³/h)



DWS on Custom Hand Grinding
38,500 cfm (65,398 m³/h)



DFO on Plasma Cutting
5,000 cfm (8,493 m³/h)



DFO on Welding Fumes
53,000 cfm (90,028 m³/h)
Left: outside Right: inside



DFO on Laser Cutting
3,100 cfm (5,266 m³/h)



TG on Plasma Cutting
3,400 cfm (5,775 m³/h)



DFO & Cyclone on Thermal Spray
4,800 cfm (8,154 m³/h)



DFO on Metal Grinding
31,000 cfm (52,658 m³/h)



DFO on Thermal Spray
8,500 cfm (14,439 m³/h)



DFO on Metallizing
Powder Flame
20,500 cfm (34,822 m³/h)

MIST APPLICATIONS



DMC on Machining
800 cfm (1,359 m³/h)



DMC on Wet Machining
390 cfm (662 m³/h)



WSO on Oil Mist
20,000 cfm (33,973 m³/h)



WSO - Horizontal Grinder
850 cfm (1,444 m³/h)



WSO at M3 Achining Center
1,200 cfm (2,038 m³/h)



WSO on Cold Forming
1,200 cfm (2,038 m³/h)



Modular Mediafilter™ on Grinding
2,000 cfm (3,397 m³/h)

PROCESSING/POWDER & BULK APPLICATIONS



DFE on Rubber Hose Cutting
2,800 cfm (4,757 m³/h)



DFO on Paint & Pigment
1,200 cfm (2,038 m³/h)



DFO on Plastics Routing
16,000 cfm (27,184 m³/h)



CPC on Milk Powder
1,200 cfm (2,038 m³/h)



MB on Glass Processing
25,000 cfm (42,466 m³/h)



DWS on Granite Finishing
22,000 cfm (37,370 m³/h)



DLMC on Paper Dust
27,000 cfm (45,864 m³/h)



DLMC on Rock Crushing
41,000 cfm (69,645 m³/h)

GRAIN & NUT APPLICATIONS



LP on Almond Dust
300,000 cfm (509,595 m³/h)



CPV - Direct Bin Venting Distributor Head
2,400 cfm (4,077 m³/h)



LP on Nut Dust
280,000 cfm (475,622 m³/h)



RF - Grain Terminal
34,000 cfm (57,754 m³/h)



CPC - Grain Tripper Conveyor
18,700 cfm (31,765 m³/h)



RF - Grain Terminal
61,000 cfm (103,618 m³/h)



DFO on Corn Husking & Sorting
28,500 cfm (48,412 m³/h)

CEMENT APPLICATIONS



CPV - Pneumatically Filled Storage Bin
1,200 cfm (2,038 m³/h)

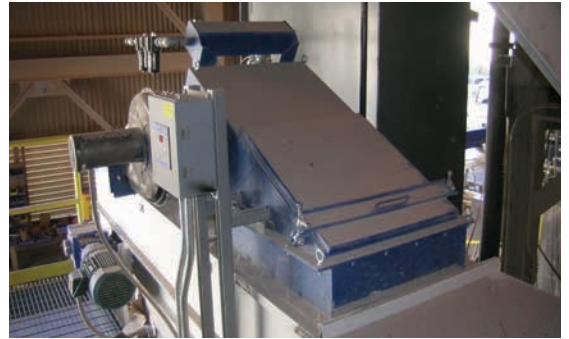

CPV - Weigh Belt Feeder
800 cfm (1,359 m³/h)



CPV - Multiple Cement Silos
4,800 cfm (8,154 m³/h)



CPV - Feed Hopper
350 cfm (595 m³/h)



CPV - Multiple Cement Silos
4,800 cfm (8,154 m³/h)



DFO - Concrete Roof Manufacturer
3,000 cfm (5,096 m³/h)



CPV - Bucket Elevator
1,200 cfm (2,038 m³/h)

WOODWORKING APPLICATIONS



UMA - School Wood Shop
2,000 cfm (3,397 m³/h)



CPC - Furniture Manufacturing
5,400 cfm (9,173 m³/h)



FS on Woodworking
20,000 cfm (33,973 m³/h)



DFO on Sawdust
57,500 cfm (97,692 m³/h)



LP on Wood Dust
160,000 cfm (271,784 m³/h)



RF - Cabinet Shop
48,500 cfm (82,385 m³/h)



RF - Wood Furniture Facility
403,000 cfm (684,556 m³/h)



IRD - Wood Shop
5,000 cfm (8,493 m³/h)

ORIGINAL EQUIPMENT MANUFACTURERS

CUSTOM SOLUTIONS FOR OEMS

OEMs have come to rely on Donaldson® Torit® to solve their filtration issues. Donaldson Torit offers flexible solutions customized to OEMs across a wide range of industries.

Donaldson Torit's reputation has been built on its problem solving, quality solutions, and commitment to customers' satisfaction even after the sale. And Donaldson Torit's worldwide network allows it to provide local support that's responsive and comprehensive – no matter where it's needed.

A dedicated team of OEM account managers and engineers stands ready to solve even the most complex filtration issue.

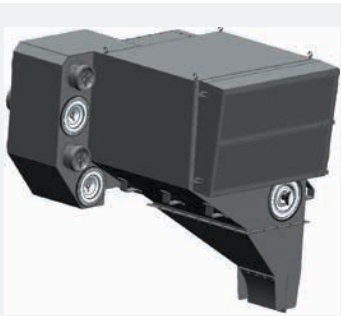

MOBILE MINING APPLICATION

Donaldson Torit can design solutions to accommodate customer space constraints and integrate additional filtration technologies tailored to customer needs.



RAIL GRINDING

Custom designs that accommodate unique customer space constraints are available.

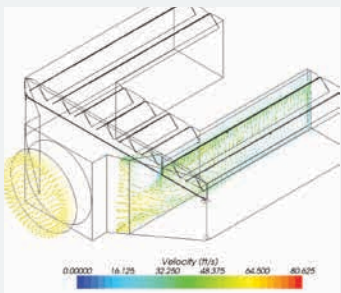

AIRFLOW MODELING ABRASION MODELING STRUCTURAL ANALYSIS

Only Donaldson Torit provides sophisticated engineering analysis tools to ensure proper airflow management, extended filter life, and reduced maintenance costs.



PLASMA CUTTING

Donaldson Torit engineers can provide a unique, integral pre-separator for spark reduction in laser and plasma cutting.

ANCILLARY PRODUCTS & REPLACEMENT PARTS

COMPLETING THE FILTRATION SYSTEM

Donaldson® Torit® understands that high performance dust, fume and mist collectors are just the first step in keeping plants cleaner and more productive. Donaldson Torit's high performance ancillary products quickly and cost-effectively complete the system, whether a manufacturer is installing a new filtration system or expanding an existing filtration line.



Easy Duct™

Easy Duct ductwork eliminates time-consuming operations like riveting, cutting, brazing, and welding for standard length piping. Easy Duct can be assembled and taken apart with no special tools, saving ducting each time a floor plan changes.



Delta P and Delta P Plus Controls

Delta P or Delta P Plus Controls are a key element of dust collector maintenance, measuring pressure drop across the filters to determine when servicing is needed. Recommended for all continuous-duty dust collection systems, Delta P monitors pressure drop so that filters are cleaned only when necessary, reducing compressed air usage and prolonging filter life.

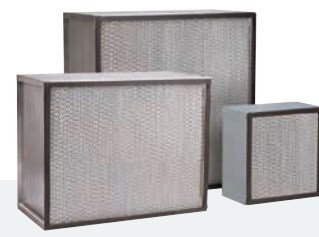

HEPA & 95% DOP Filters

Providing a high filtration efficiency of 99.97% at 0.3 microns, HEPA filters can be used as afterfilters for dust, fume and mist collection. Also available are panel filters with 95% DOP media or 95% ASHRAE media.



Rotary Valves

Rotary Valves offer an economical solution for automated handling of most discharge dust. Available in three models: high pressure, low pressure, and sweeper valves. Rotary valves provide continuous dust disposal that keeps hoppers and collectors operating at peak performance, thereby reducing dust collector maintenance time and cost.



Fans

Torit Backward Inclined (TBI) direct drive fans are available in sizes ranging from 3 hp to 30 hp. The TBI fan mounts directly to the clean-air plenum of the dust collector, eliminating costly transition ducting. **Torit Radial Blade (TRB)** fans are an economical, dependable radial fan with a direct-drive design to eliminate maintenance on fan bearings and belts. The TRB is available in sizes from 1 hp to 10 hp.

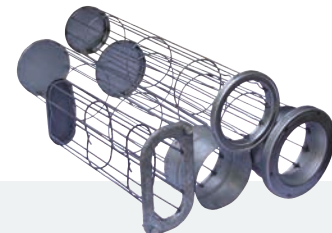

Cages

Replacement cages are available for Donaldson Torit baghouse collectors as well as many other popular makes and models. Cages are available in galvanized or stainless steel for ambient, high temperature, or highly corrosive environments.

REPLACEMENT FILTERS

COMPREHENSIVE OFFERING FOR A VARIETY OF EQUIPMENT BRANDS



Using Donaldson® Torit® replacement filters can significantly improve the performance of dust collectors. Uniquely engineered for longer filter life and higher filtration efficiency, Donaldson Torit cartridge and bag filters are the most cost-effective choice for any collector and any application.

Rely on Donaldson Torit for all popular brands of collectors. With hundreds of varieties to choose from and all in-stock orders shipped within 24 hours, Donaldson Torit has exactly what you need when you need it!

No other filter manufacturer can match Donaldson Torit's technical expertise and commitment. For knowledgeable support and to determine the right filters for a specific application, call Donaldson Torit's customer service representatives at 800-365-1331 or visit www.donaldsontorit.com

DURA-LIFE™ for baghouse collectors

- AZO®
- Buhler
- Carter Day
- DCE
- Flex-Kleen
- Golfetto
- Kice
- MAC
- MikroPul
- Murphy
- Pneumafil
- Steelcraft®
- Wheelabrator
- + Many others

**READY
2SHIP**



ULTRA-WEB® for cartridge collectors

- AAF®
- Aercology®
- Airflow® Systems
- Clemco®
- Environmental Systems Designs
- Farr
- Geoff
- MAC
- Micro Air®
- Nordson
- Pneumafil
- Robovent®
- Steelcraft®
- Trion®
- UAS®
- Wheelabrator
- + Many others

**CALL 800-365-1331 FOR LIVE SUPPORT
VISIT DONALDSONTORIT.COM**

Industry-Leading Technology

- Advanced filtration technology for optimal performance
- Reduced energy consumption and cost of ownership
- Advanced design and testing capabilities

The Most Filters and Parts

- For every brand and style of collector
- Wide range of filtration media for any application
- 90,000 filters and parts in stock and ready to ship

Unparalleled Support

- Live technical specialists
- Comprehensive pre- and post-sale support
- 40 manufacturing plants and 14 distribution centers worldwide

Significantly improve the performance of your collector with genuine Donaldson Torit replacement filters and parts. **Call Donaldson Torit at 800-365-1331.**

Important Notice

Many factors beyond the control of Donaldson can affect the use and performance of Donaldson products in a particular application, including the conditions under which the product is used. Since these factors are uniquely within the user's knowledge and control, it is essential the user evaluate the products to determine whether the product is fit for the particular purpose and suitable for the user's application. All products, product specifications, availability and data are subject to change without notice, and may vary by region or country.



Donaldson.

Donaldson Company, Inc.
Minneapolis, MN
donaldson.com • shop.donaldson.com

North America
Email: donaldson@donaldson.com
Phone: (USA): +1-800-365-1331 • (MX): +1-800-343-36-39

Australasia
Email: marketing.australia@donaldson.com
Phone: +61-2-4350-2000
Toll Free: (AU) +1800-345-837 • (NZ) +0800-743-387

F118021 ENG (08/20) General Brochure ©2011-2020 Donaldson Company, Inc. Donaldson, Torit, Dalamatic, Delta P, Delta P Plus, Downflo, Dura-Life, Easy Duct, PowerCore, Synteq XP, Ultra-Web, Unimaster and the color blue are marks of Donaldson Company, Inc. All other marks belong to their respective owners.

China
Email: info.cn@donaldson.com
Phone: +86-400-820-1038

Donaldson Europe B.V.B.A.
Email: IAF-europe@donaldson.com
Phone: +32-16-38-3811

India
Email: info.difs@donaldson.com
Phone: +91-124-4807-400 • +18001035018

Japan
Email: jp-ndl.lifswb@donaldson.com
Phone: +81-42-540-4112

Korea
Email: iaf-kr@donaldson.com
Phone: +82-2-517-3333

Latinoamerica
Email: IndustrialAir@donaldson.com
Phone: +52-449-300-2442

South Africa
Email: SAMarketing@donaldson.com
Phone: +27-11-997-6000

Southeast Asia
Email: IAFSEA@donaldson.com
Phone: +65-6311-7373